

DECEMBER 12, 2024



AMMONIUM BICARBONATE FOOD GRADE
DATA PACKAGE

Table of Contents

1. Letter to Our Customers
2. General
 - Product
 - Supplier
 - Manufacturer
3. Product Details
 - Product References
 - Storage
 - Compliance
 - Packaging
 - Contaminants
 - Residual
 - BSE/TSE/GMO
 - Composition
4. Manufacturing
 - Site Information
 - Process
 - Manufacturing Information
 - Quality system
 - Lot Numbering System
 - Products Not Used in Manufacturing of Product
5. Food Information
 - Food Information
 - Diet Suitability
 - Microbiological
 - Nutritional Value
6. Documents

Letter to Our Customers

Dear Valued Customer,

Over the past few years, Esseco USA has received a significant increase in the number of questionnaires, surveys, and document requests from our customers.

Most of these requests focus on the same product, manufacturing, quality, and safety issues.

Moving forward, we will be unable to complete each customer's specific documentation requests.

In order to respond to all of these varied types of requests, Esseco USA has generated a comprehensive product specific Data Package (Data Pack) that will provide most if not all of the requested information.

We are confident that this Data Pack will ensure that consistent information is provided in a timely and efficient manner. The Data Pack is updated annually to ensure all data is accurate, and additionally the Data Pack will be updated in reaction to major regulatory changes.

Sincerely



Esseco USA Technical Services

All statements, information, and data given herein are believed to be accurate and reliable but are presented without guaranty, warranty, or responsibility of any kind, express or implied. Statements or suggestions concerning possible use of our products are made without representation or warranty that any such use is free of patent infringement, and are not recommendations to infringe any patent. The user should not assume that all safety measures are indicated or that other measures may not be required. All suggestions made herein are intended for use by persons having requisite knowledge and skill, and are to be utilized at their own risk. Esseco USA assumes no responsibility for this information, and potential purchasers waive all claims they may have and agree to indemnify and hold harmless Esseco USA from any claims or damages they may later allege relative to their reliance upon these suggestions.

General

Product

Name	Ammonium Bicarbonate Food Grade
Code	1AJANE

Supplier

Name	Esseco USA
Address	4 Gatehall Drive, Parsippany, NJ 07054
Phone	973-267-3330
Internet	https://www.essecousa.com/

Manufacturer

Name	Addcon Nordic AS
Address	Herøya Industrial Park B-85, Hydrovegen 55, 3936 Porsgrunn, Norway
Phone	+47 35 56 41 00
Internet	https://www.addcon.com/index.php/en/
Country of Origin	Norway

Products Details

Product References

- CAS No. (Chemical Abstracts Service): 1066-33-7
- EC No. (European Inventory of Existing Commercial Chemical Substances): 213-911-5
- E No. (EU number for additives): E503
- REACH (Registration, Evaluation, Authorization of Chemicals): registration number 01-2119486970-26

Storage

- Store the product (in original packaging when possible) in a cool (below 85 F), well-ventilated, and dry indoor location.
- Shelf-life is 24 months from date of manufacture when stored in original container
- The characteristics of the product might cause the formation of agglomerates and lumps over time, typically from 12 months onward. The formation of agglomerates and lumps will not influence the active substances and the chemical characteristics of the product.

Compliance

- Regulation (EU) No 231/2012 (food additives)
- Food Chemicals Codex(FCC) XII

Packaging

- The packaging used for the Ammonium Bicarbonate sold by Esseco USA is suitable for food contact.
- The Ammonium Bicarbonate sold by Esseco USA is packaged on pallets that have been heat treated and made from European wood. No fungicides including 2,4,6 tribromophenol (TBP) or 2,4,6 trichlorophenol (TCP) are used on any pallets for this product.
- All the Ammonium Bicarbonate that is sold in 25 kg bags by Esseco USA has gone through a metal detection device when it was packaged.

Residual

- The Ammonium Bicarbonate sold by Esseco USA does not contain any of the solvents listed in the United States Pharmacopeia general chapter <467> (Class 1, Class 2, Class 3, or other Table 4), the European Pharmacopeia, or the International Conference on Harmonization of Technical Requirements for Registration of Pharmaceuticals for Human Consumption (ICH) Residual Solvent (OVI) Lists. In addition, it does not contain any other organic solvents.

Composition

Component	Percent	CAS Number
Ammonium Bicarbonate	99.4	1066-33-7
Magnesium Carbonate	0.6	546-93-0
Total:	100.0	

Manufacturing

Site Information

- Size of Site 200,500 sq ft
- Total Employees 57
- Production Staff 35
- Quality Unit Staff 2
- Quality Assurance Staff 2

Process

- The Ammonium Bicarbonate food grade is manufactured using a synthetic process.
- This is a continuous process in a closed plant
- The raw materials of ammonia and carbon dioxide are reacted and then concentrated until the required density is reached.
- The crystalline product is separated by centrifuge and dried.
- The dried product is blended with the additive Magnesium Carbonate.
- The process is controlled by an automatic system with periodic testing and adjustments performed by the operators.
- The product is packaged in a closed line, equipped with a metal detector.

Manufacturing Information

- The Ammonium Bicarbonate sold by Esseco USA has not been irradiated.
- The product is manufactured using current Good Manufacturing Practices (cGMP).

Quality System

- The plant maintains a FSSC 22000 Certification which meets the Global Food Safety Initiative(GFSI).
- The plant maintains an ISO 9001:2015 Certification.
- The plant has an FDA registration number of 17179467870.

Lot Numbering System

- Numbering System Explanation

The first two numbers designate the day of the month.
The following three letter designate the calendar month.
The last four numbers designates the year of production.

- Example for Lot Number 22.Jun.2022

22 – Day on month of Manufacture, 22
Jun – Calendar month, June
2022 - Product was packaged in 2022

Products Not Used in Manufacturing of Product

This product does not contain and hasn't been in contact with the following:

- Melamine
- Pesticides
- Residual Solvents (US & Europe Pharmacopeia Listings)

Food Information

Food Information

- This product is a substance that is generally recognized as safe (GRAS) per Title 21 of the Code of Federal Regulations Part 184.1135 (2020).
- The product is in compliance with all Kosher requirements.
- The product is in compliance with all Halal requirements.
- The product does not contain any ingredients of animal origin or alcohol. Furthermore, we can exclude any risk of environmental contamination during manufacture, filling, packing, transportation and storage.
- The Food grade Ammonium Bicarbonate sold by Esseco USA meets all of the requirements of the US Food and Drug Administration (FDA) Food Safety Modernization Act (FSMA).
- Esseco USA is the importer of record for the Food grade Ammonium Bicarbonate sold by Esseco USA and has taken all of the necessary steps to be compliant with the United States Food and Drug Administration's Foreign Supplier Verification Program (FSVP) for importers of food for humans and animals.

Diet Suitability

The product is suitable for:

- Vegans
- Lacto / Ovo-lacto vegetarians
- Diabetics
- Lactose intolerants
- Celiacs

Microbiological

The Ammonium Bicarbonate sold by Esseco USA has been tested and does not contain microbiological hazards. Retesting is done on an annual basis.

BSE/TSE/GMO/BE

This is to certify that Ammonium Bicarbonate sold by Esseco USA does not contain any materials that are of organic or animal origin. In addition, it does not come in contact with materials of organic or animal origin in its manufacture. Therefore, it is BSE / TSE compliant and contains no Genetically Modified Organisms (GMO's) or Bioengineered(BE) materials.

Documents

Reference Documents

- ISO 9001:2015 Quality Management System
- HACCP Chart
- Allergen Statement
- FSSC 22000 GFSI Certification
- Kosher Certificate
- Halal Certificate
- Nutrition Statement

Other Documents

- Certified Food Grade Guarantee
- Organizational Chart
- Bioterrorism Statement
- 25 KG Package Label



AMMONIUM BICARBONATE FOOD GRADE DATA PACKAGE REFERENCE DOCUMENTS

ISO 9001:2015 Quality Management System	Page 2
HACCP Chart	Page 3-4
Allergen Statement	Page 5
FSSC 22000 GFSI Certification	Page 6
Kosher Certificate	Page 7
Halal Certificate	Page 8
Nutrition Statement	Page 9

MANAGEMENT SYSTEM CERTIFICATE

Certificate no.:
167759-2014-AQ-DEN-DANAK

Initial certification date:
15 December 2006

Valid:
25 August 2021 – 13 July 2024

This is to certify that the management system of
ADDCON Nordic AS
Hydrovegen 55, Herøya Industripark B-85, 3936 Porsgrunn, Norway

has been found to conform to the Quality Management System standard:
ISO 9001:2015

This certificate is valid for the following scope:

Production, sales, distribution and marketing of organic acids, their salts and bases: Feed additive and premixtures for use in poultry's and pig's food. De-icing liquid used for de-icing runways/open areas. Ensiling agent for grass enables higher energy intake by ruminants. Preservation agent for fishmeal industry, fish byproducts and slaughter facilities on land. Production of Potassium formate (liquid and solid) as Drill-in and completion fluid for use within the oil and gas industry. Secondary refrigerant for use in indirect cooling system. Amoniumbicarbonate rising agent for use in food.

Place and date:
Hellerup, 25 August 2021



For the issuing office:
DNV - Business Assurance
Tuborg Parkvej 8, 2., 2900 Hellerup, Denmark

Jesper Schultz
Management Representative

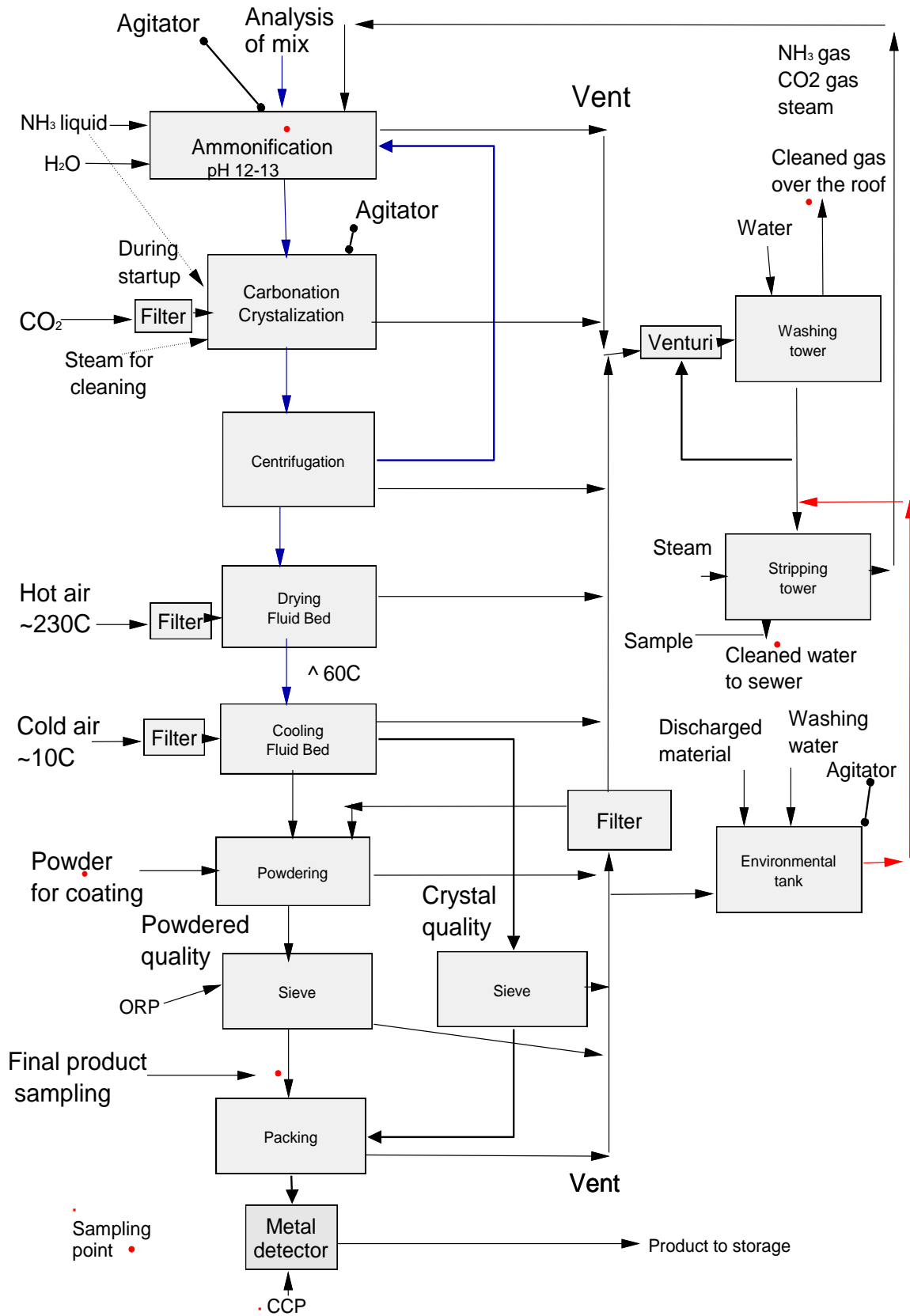

TRANSPORT OF RAW MATERIAL

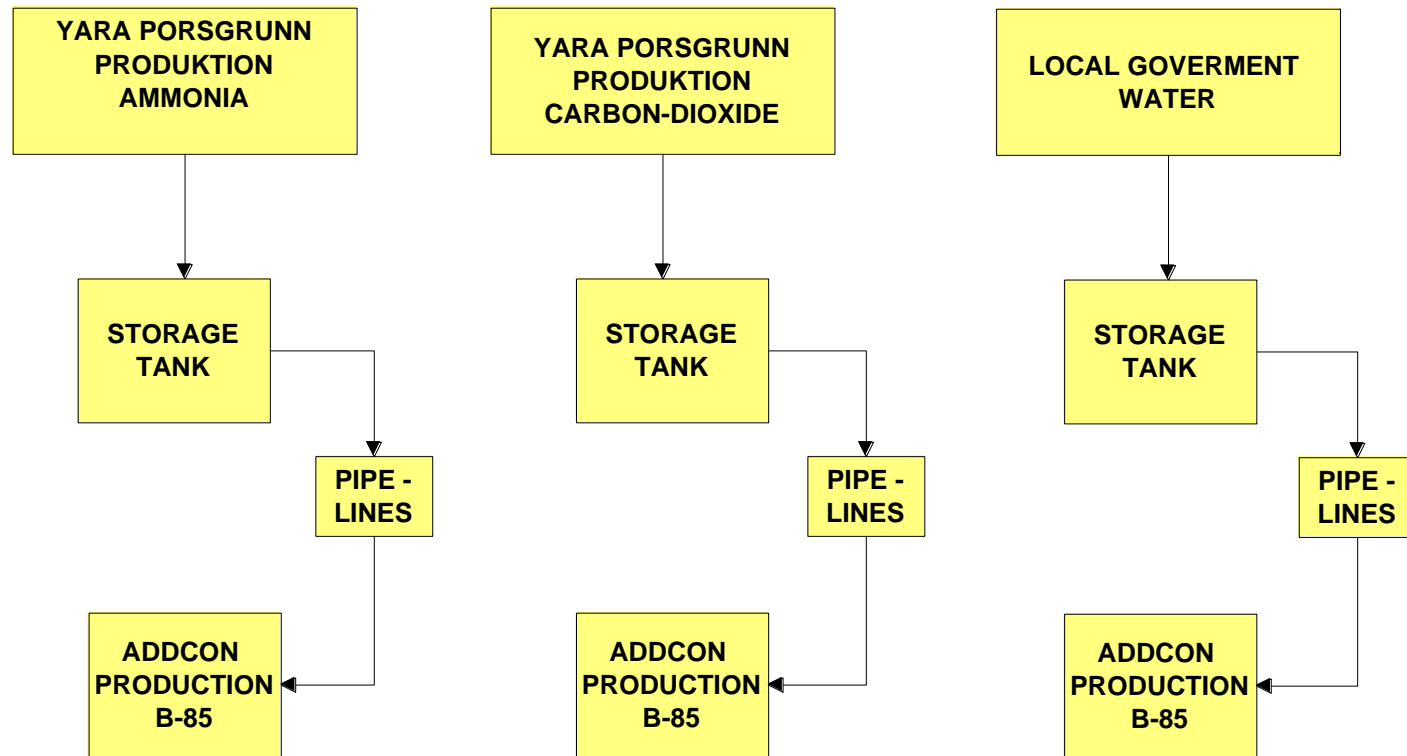

March 31, 2022

Manufacturer ADDCON Nordic AS

ALLERGENS STATEMENT

We can confirm that our Ammonium bicarbonate (ABC) is not produced with raw materials which are influenced by allergens and that we do not use allergenic materials in the engineering processes.

The list of allergens below is according to Directive 2000/13/WE as amended Directive 2003/89/EC, 2007/68/EC and 1169/2011/EC.

Our ammonium bicarbonate does not contain any of the following known allergens:

Artificial Sweeteners.

Celery and products thereof.

Colorants.

Crustaceans and products thereof

Dyes.

Egg or Egg Products.

Gluten (Wheat, Barley, Rye, or Oats) products thereof.

Other cereals containing gluten and products thereof (rye, barley, oat, spelt, kamut, rice and wild rice, sorghum, buckwheat, millet, quinoa).

Fish and products thereof.

Lactose.

Latex..

Lupin and products thereof

Molluscs and products thereof..

Milk or Milk Products (cow's milk proteins, lactose...).

Monosodium Glutamate (MSG)

Mustard and products thereof.

Peanuts or Peanut Products.

Preservatives.

Seafood or Seafood Products (Fish or Shellfish).

Seeds or Seed Products (Cotton, Poppy, Sesame, or Sunflower).

Soybeans or Soybean Products.

Nuts or Nut Products (Almond, Brazil, Cashew, Chestnut, Hazelnut, Pine, Pistachio, Pecan, Macadamia, or Walnut).

Wheat or Wheat Products.

Sulphur dioxide and sulphites are not contained in concentrations of more than 10mg/kg.



Øyvind O Due
HSEQ Manager
ADDCON Nordic AS

Postal address:

ADDCON Nordic AS
P.O Box 1138
3905 Porsgrunn
Norway

Visiting address:

ADDCON Nordic AS
Herøya Industrial Park B-85
Hydrovegen 55
3936 Porsgrunn
Norway

Production address:

ADDCON Nordic AS
Herøya Industrial park B-85
Hydrovegen 55
3936 Porsgrunn
Norway

Tlf No:

+47 35 56 41 00

Registration No:
NO 988 774 677 MVA



MANAGEMENT SYSTEM CERTIFICATE

Certificate no.:
C620347
COID Code:
NOR-1-2080-429522

Initial certification date:
15 December 2006

Valid:
03 July 2024 – 02 July 2027

This is to certify that the Food Safety Management System of
ADDCON Nordic AS
Hydrovegen 55, Herøya Industripark B-85, 3936 Porsgrunn, Norway

has been assessed and determined to comply with the requirements of
FSSC 22000

Certification scheme for food safety management systems consisting of the following elements:
ISO 22000:2018, ISO/TS 22002-1:2009 and Additional FSSC 22000 requirements (Version 6).

This certificate is applicable for the scope of:

Production of ammonium bicarbonate as food ingredient. Category K

Date of Certification Decision:
12 August 2024

Date of the last unannounced audit:
29-30 June 2022

Issue Date / Place and date:
Vimercate (MB), 13 August 2024

DNV:



FSSC:



MS N°0003

Membro degli Accordi di Mutuo Riconoscimento EA, IAF
e ILAC. Signatory of EA, IAF and ILAC Mutual
Recognition Agreements

For the issuing office:
DNV Business Assurance Italy S.r.l.
Via Energy Park, 14, - 20871 Vimercate (MB) -
Italy



Sabrina Bianchini
Management Representative

January 11, 2024

ר"ח שבט ה'תשפ"ד

KOSHER CERTIFICATE

אישור כשרות

I hereby certify that the **Ammonium Bicarbonate**, manufactured by **ADDCON Nordic AS in Porsgrunn, Norway**, is Kosher Parve also for Passover.

הריני מאשר כי האמונניום ביקרבונאט המיוצר ע"י חברת אדכון במפעל בפורשגרון, נורבגיה, הינו כשר פרווה גם לפסח.

- This certificate is valid until January 20, 2025.

- תוקף תעודה זו: כי בטבת ה'תשפ"ה

Rabbi Joav Melchior
Rabbi of Oslo, Norway



הרב יואב מלכיאור
הרב דק"ק אוסלו, נורבגיה





المجلس الإسلامي في النرويج

HALAL CERTIFICATE

Certificate number: IRN243422

Valid until: 31.12.2024

The Islamic Council of Norway (IRN) certifies that company:

ADDCON Nordic AS

Herøya Industripark, Bygg 85,
Hydrovegen 55, 3936 Porsgrunn, Norway
Organisation number: 988774677
VAT no.: NO 988774677MVA

Has undergone audit for following production unit only:

Herøya Industripark, Bygg 85, Hydrovegen 55, 3936 Porsgrunn, Norway

The auditing includes inspections on all aspects of the operations, such as documentation, raw materials, processes, handling, tools, storage, cleanliness, packaging, and labeling.

The production unit has been certified for following products, which are produced in a *Sharia-compliant* facility and in accordance with *Sharia law* of halal and haram:

Pos.	Product name
1	Ammonium bicarbonate
2	Formi NDF
3	ADDCON XL 2.0

Date: 04.12.2023

Certificate issued by: Islamic Council of Norway

Islamsk Råd Norge (IRN)

halal@irn.no

www.irn.no

A registered organization in Norway,
org. no.: 982842840

Signature:

Masoom Zubair
Chairman IRN



NUTRITIONAL VALUE OF AMMONIUM BICARBONATE

Unit of Measurement, 100 Grams

Total Fat:	0 g
Saturated Fat:	0 g
Trans Fat:	0 g
Cholesterol:	0 mg
Sodium:	0 mg
Total Sugar:	0 g
Added Sugar:	0 g
Fiber, dietary:	0 g
Protein:	0 g
Total Carbohydrates:	0 g
Available Carbohydrates:	0 g
Ash:	0.55 g
Water:	0.25 g
Vitamin A:	0 µg
Vitamin C	0 µg
Vitamin D:	0 µg
Energy:	0 kcal
Calcium:	0 mg
Magnesium:	158 mg
Iron:	0 mg
Potassium:	0 mg

January 1, 2024

TECHNICAL SERVICE
Phone: 973 267 3330
Fax: 973 267 8299



AMMONIUM BICARBONATE FOOD GRADE DATA PACKAGE OTHER DOCUMENTS

Certified Food Grade Guarantee	Page 2
Organizational Chart	Page 3-10
Bioterrorism Statement	Page 11
25 KG Package Label	Page 12



**GUARANTEE UNDER SECTION 303 (C) (2) OF THE
FEDERAL FOOD, DRUG, AND COSMETIC ACT**

FOR THE PURPOSE OF SECTION 303(C) (2) OF THE FEDERAL FOOD AND COSMETIC ACT, WE HEREBY GUARANTEE THAT, AS OF THE DATE OF EACH SHIPMENT BY US TO YOU OF ANY ARTICLE LISTED BELOW SUCH ARTICLE IS NOT, WHEN SHIPPED, ADULTERATED OR MISBRANDED WITHIN THE MEANING OF THE FEDERAL FOOD, DRUG, AND COSMETIC ACT OR OF ANY APPLICABLE STATE LAW IN WHICH THE DEFINITIONS OF ADULTERATION AND MISBRANDING ARE THE SAME AS THOSE CONTAINED IN THE FEDERAL FOOD, DRUG, AND COSMETIC ACT. WE FURTHER GUARANTEE THAT, AS OF THE DATE OF EACH SHIPMENT, NO SUCH ARTICLE IS AN ARTICLE WHICH MAY NOT, UNDER THE PROVISIONS OF SECTION 404 OR 505 OF THE FEDERAL FOOD, DRUG, AND COSMETIC ACT, BE INTRODUCED INTO INTERSTATE COMMERCE.

THIS GUARANTEE SHALL NOT EXTEND TO COVER THE RESPONSIBILITIES OF A DISTRIBUTOR IN SITUATIONS WHERE THE ARTICLE IS TRANSFERRED IN BULK OR IS REPACKAGED. MOREOVER, THIS GUARANTEE SHALL BE VOID AND OF NO EFFECT IN ANY INSTANCE WHERE THE PARTICULAR USE BY YOU OF ANY ARTICLE TO WHICH THIS GUARANTEE WOULD OTHERWISE APPLY IS A USE WHICH IS NOT IN ACCORDANCE WITH THE REQUIREMENTS OF THE FEDERAL FOOD, DRUG, AND COSMETIC ACT OR APPLICABLE STATE LAWS.

THIS GUARANTEE SHALL BE A CONTINUING GUARANTEE AND SHALL CONTINUE IN EFFECT FOR A PERIOD OF FIVE YEARS FROM THE DATE HEREOF, OR UNTIL SUCH EARLIER DATE AS YOU SHALL RECEIVE FROM US WRITTEN NOTICE OF THE REVOCATION OF THE GUARANTEE CONTAINED HEREIN OR A CHANGE IN FEDERAL REGULATION OCCURS.

PRODUCT	GRADE	CODE
AMMONIUM BICARBONATE	FOOD GRADE	1AJANE

SIGNED: Charlie Dulik

TITLE: Sales Engineer

DATE: January 1, 2024

QMS0201 - Organization chartDokumentadministrator: Martin Sneltvedt
Godkjent av: Øyvind Oskarsen DueGyldig fra: 26.03.2024
Revisjonsfrist: 26.03.2027Revisjon: 2.0
ID: 1474**ORGANIZATION CHART**

ID:				QMS0201	Document
Originator:	Øyvind Oskarsen Due	Revision Date:	March 26th, 2024		
Approver:	Per Ove Jakobsen	Revision:			22

COTENTS:

1. Management
2. ADDCON Nordic AS, Business Organization.
3. Porsgrunn Site Organization.
4. Porsgrunn Production.
5. R&D.
6. Marked segment.
7. EHS/ Quality.
8. Admin- Logistic.
9. Logistics department.

1. ADDCON Nordic AS, Business Organization

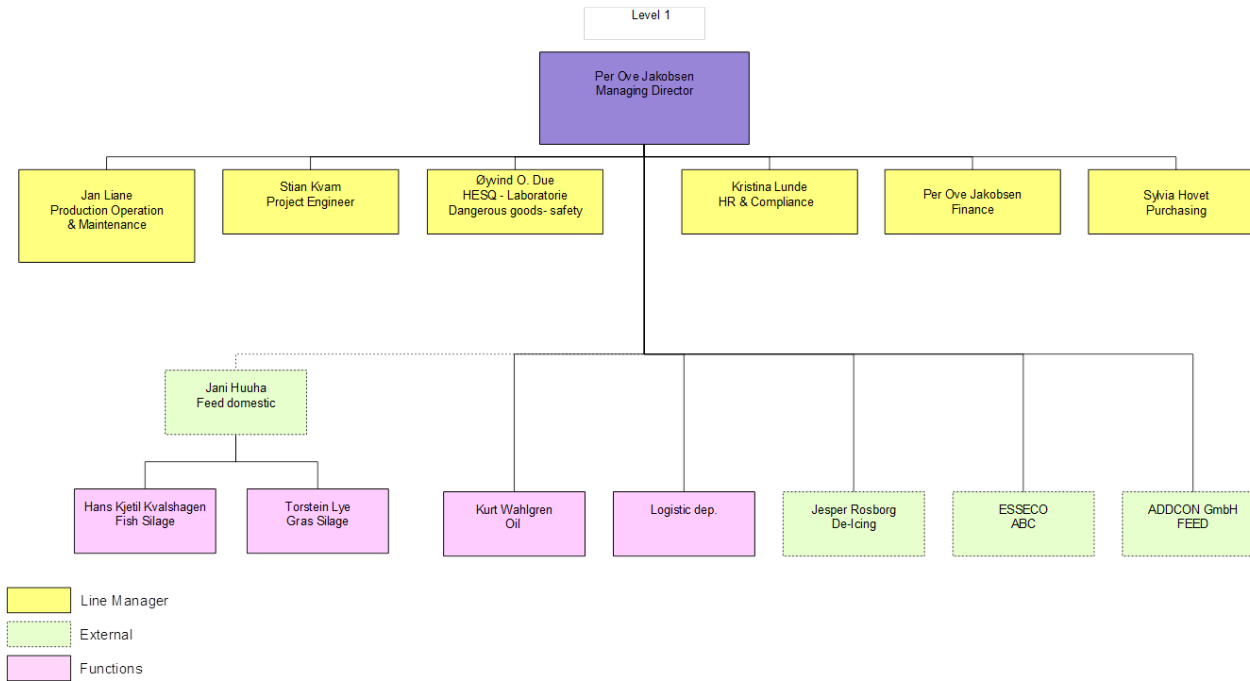

2. Porsgrunn Site Organization

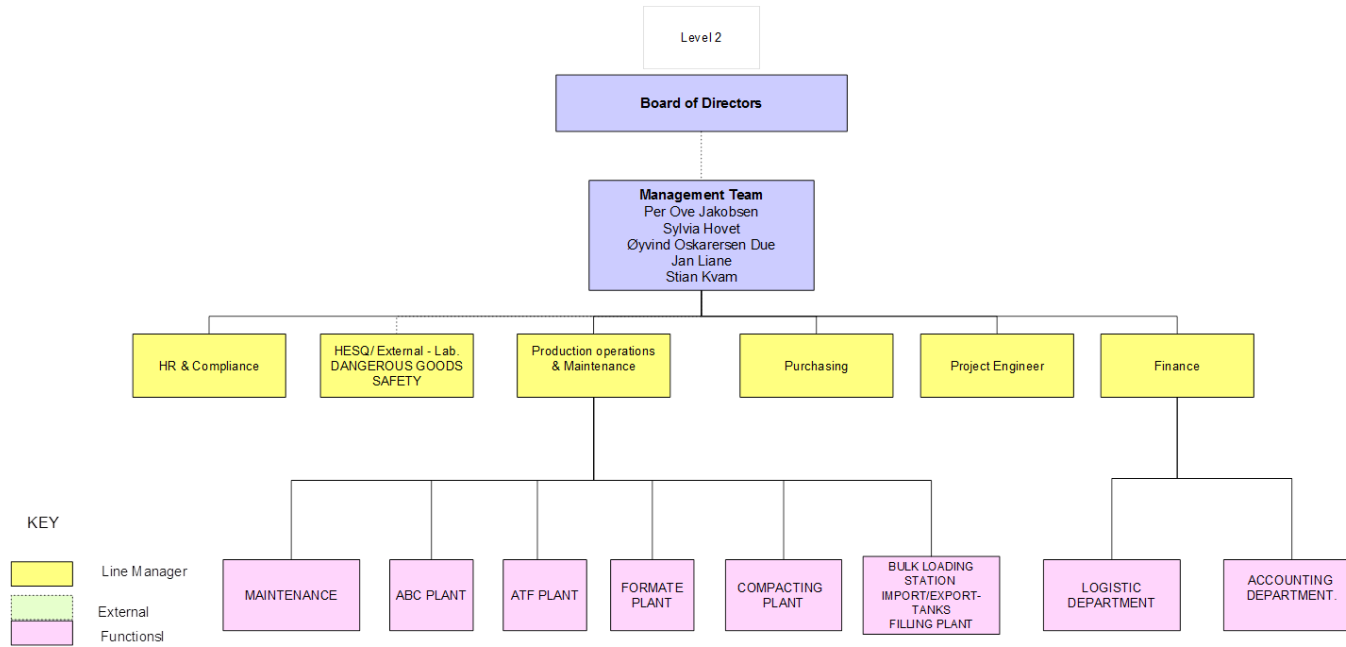

3. Porsgrunn Production.

Level 3

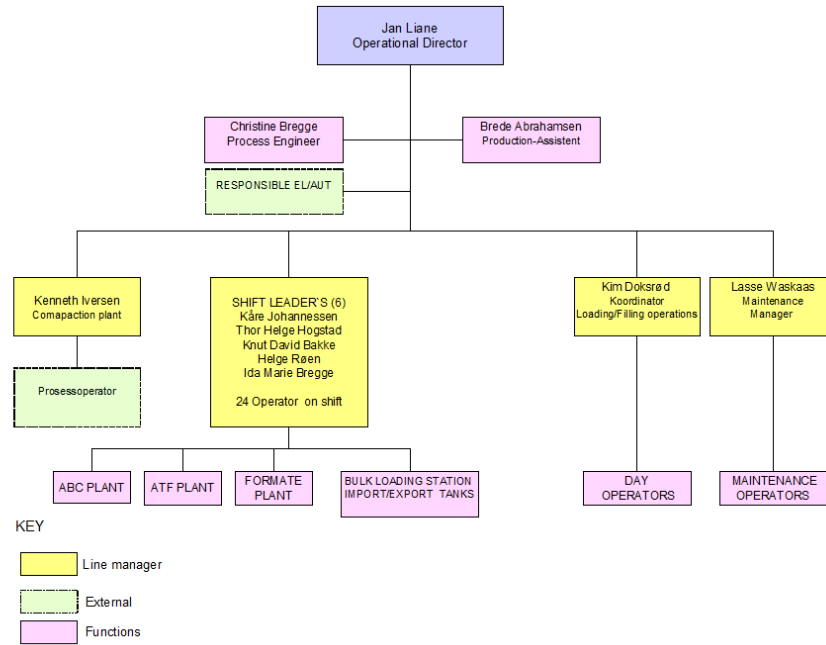

4. ADDCON Nordic / Europe R&D and Operations Organization.

Level 4

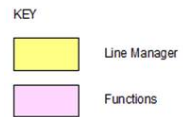
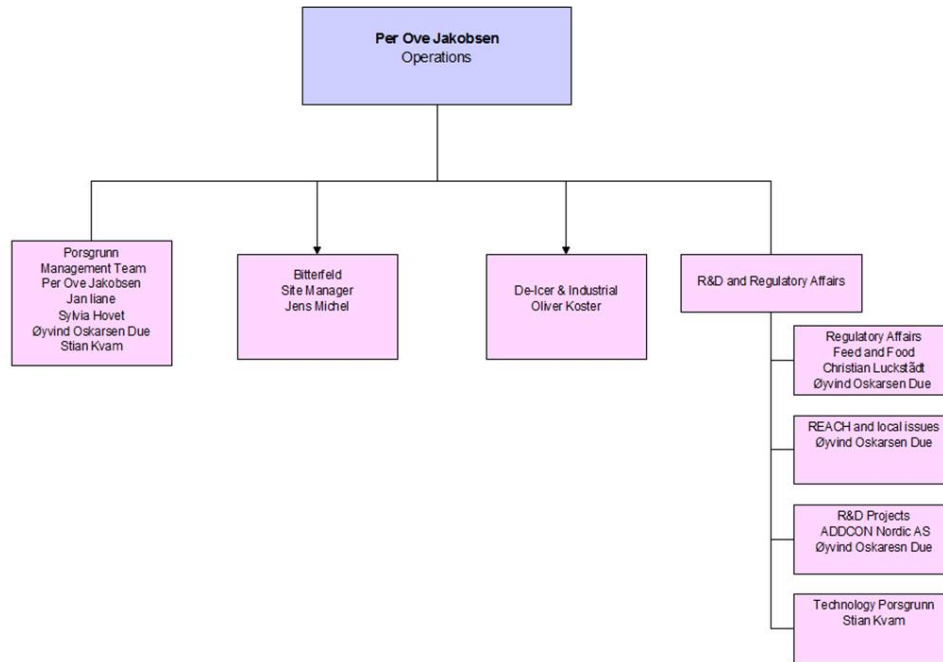

5. Marketing and sales

Level 5

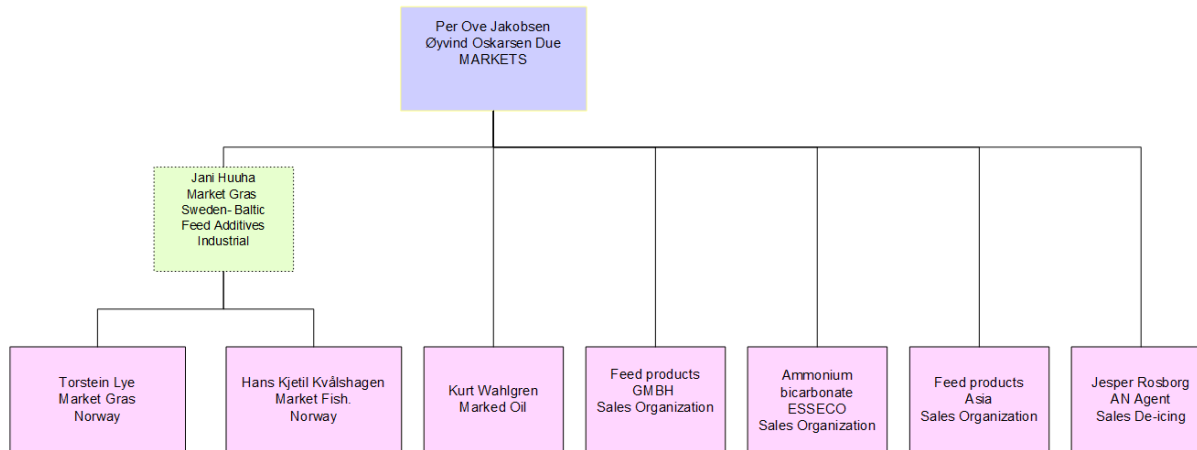

KEY

- Line manager
- External
- Functions

1

6. EHSQ

Level 6

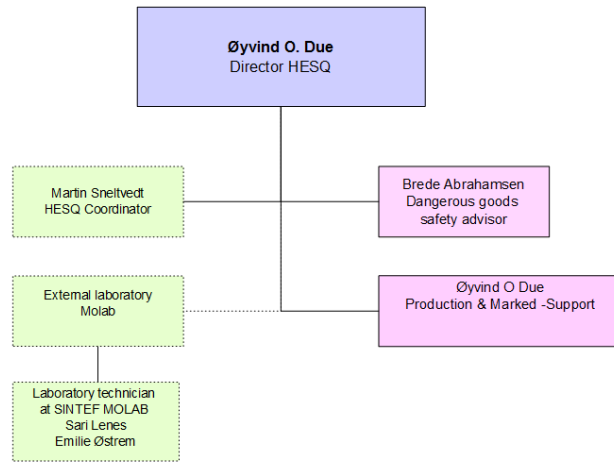



KEY

- Line Manager
- External
- Functions

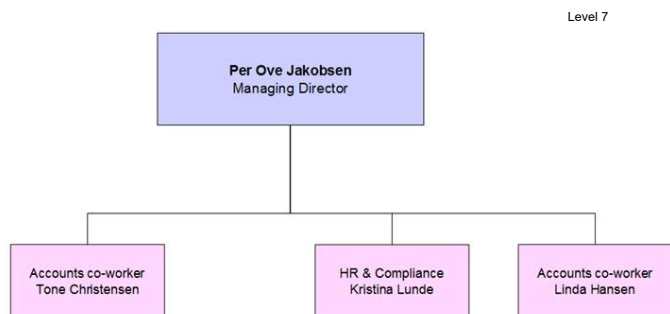
7. Finance



KEY

-  Line Manager
-  Functions

8. Logistics Department

Level 8

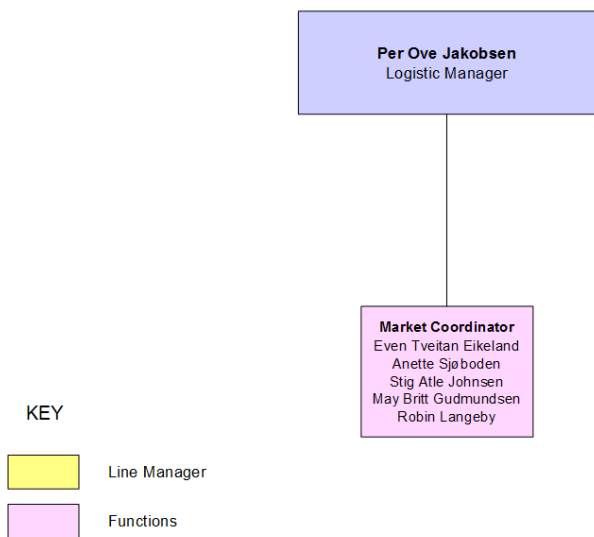

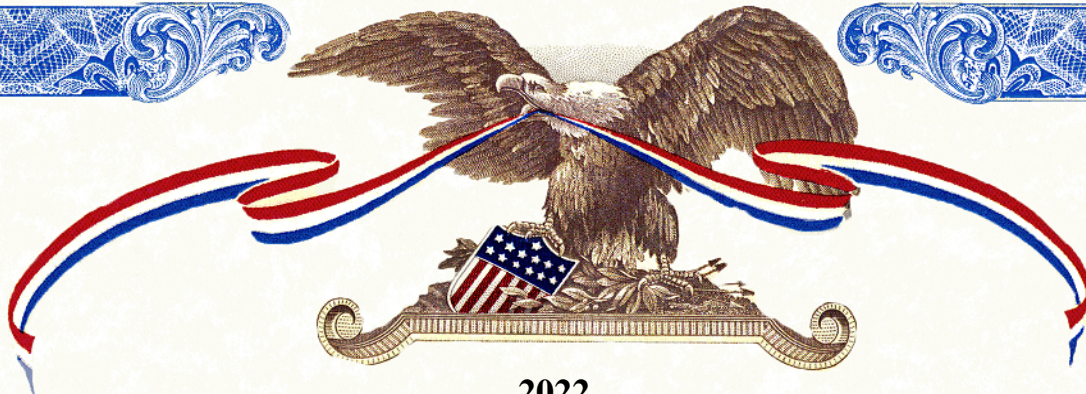

2022

CERTIFICATE OF REGISTRATION

This certifies that:

Addcon Nordic AS
Heroya Industripark B-85, Hydrovegen 55
Porsgrunn, Telemark N-3936
Norway

is registered with the U.S. Food and Drug Administration pursuant to the Federal Food Drug and Cosmetic Act, as amended by the Bioterrorism Act of 2002 and the FDA Food Safety Modernization Act, such registration having been verified as currently effective on the date hereof by Registrar Corp:

U.S. FDA Registration No.: **17179467870**
U.S. Agent for FDA **Registrar Corp**
Communications: 144 Research Drive, Hampton, Virginia, 23666, USA
Telephone: +1-757-224-0177 • Fax: +1-757-224-0179

This certificate affirms that the above stated facility is registered with the U.S. Food and Drug Administration pursuant to the Federal Food Drug and Cosmetic Act, as amended by the Bioterrorism Act of 2002 and the FDA Food Safety Modernization Act, such registration having been verified as effective by Registrar Corp as of the date hereof, and Registrar Corp will confirm that such registration remains effective upon request and presentation of this certificate until December 31, 2022, unless such registration has been terminated after issuance of this certificate. Registrar Corp makes no other representations or warranties, nor does this certificate make any representations or warranties to any person or entity other than the named certificate holder, for whose sole benefit it is issued. Registrar Corp assumes no liability to any person or entity in connection with the foregoing. The U.S. Food and Drug Administration does not issue a certificate of registration, nor does the U.S. Food and Drug Administration recognize a certificate of registration. Registrar Corp is not affiliated with the U.S. Food and Drug Administration.

Registrar Corp

144 Research Drive, Hampton, Virginia, 23666, USA
Telephone: +1-757-224-0177 • Fax: +1-757-224-0179
info@registrarcorp.com • www.registrarcorp.com

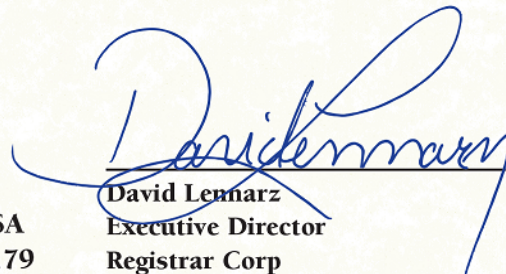
David Lennarz
Executive Director
Registrar Corp

Dated: September 21, 2021

© Copyright 2003-2020 Registrar Corp

25 kg



BICARBONATE D'AMMONIUM

FOOD GRADE FFQ - AVEC 0.9% max MgCO₃ - CODE 1AJANE-0025KB

CONTIENT BICARBONATE D'AMMONIUM CAS 1066-33-7/ AVEC CARBONATE DE MAGNESIUM CAS 39409-82-0

AVERTISSEMENT

ENTREPOSER DANS LE RÉCIPIENT D'ORIGINE DANS UN ENDROIT FRAIS, SEC, BIEN VENTILÉ ET À L'ABRI DE L'HUMIDITÉ. POUR UNE URGENCE AUX ÉTATS-UNIS ET CANADA, APPELEZ CHEMTREC 800-424-9300

AVANT D'UTILISER, CONSULTER LA FICHE DE DONNÉES DE SÉCURITÉ

EXCLUSIVEMENT POUR USAGE PROFESSIONNEL

CONTENU FABRIQUÉ EN NORVÈGE

Attention

Nocif en cas d'ingestion.

Se laver les mains soigneusement après manipulation.

Ne pas manger, boire ou fumer en manipulant ce produit. EN CAS D'INGESTION: Appeler un médecin en cas de malaise. Rincer la bouche.

Éliminer le contenu et le récipient conformément à la réglementation locale, régionale et nationale.



PIM016 (R2-0423)

ESSECO USA LLC - 4 Gatehall Drive - Parsippany, NJ 07054 - Tel 973-267-3330

55.1 lbs

AMMONIUM BICARBONATE

FOOD GRADE FFQ

ESSECO INDUSTRIAL

55.1 lbs



AMMONIUM BICARBONATE

FOOD GRADE FFQ - WITH 0.9% max MgCO₃ - CODE 1AJANE-0025KB

CONTAINS AMMONIUM BICARBONATE CAS 1066-33-7/ WITH MAGNESIUM CARBONATE CAS 39409-82-0

ATTENTION

STORE IN THE ORIGINAL CONTAINER IN A COOL, DRY, WELL-VENTILATED LOCATION THAT IS PROTECTED FROM MOISTURE. IN CASE OF AN EMERGENCY INVOLVING THIS PRODUCT IN THE USA OR CANADA CONTACT CHEMTREC 800-424-9300

BEFORE USING, READ THE SAFETY DATA SHEET FOR THIS CHEMICAL

FOR PROFESSIONAL USE ONLY

CONTENTS MADE IN NORWAY

Warning

Harmful if swallowed. Wash hands thoroughly after handling.

Do not eat, drink or smoke when using this product. IF SWALLOWED: call a doctor if you feel unwell. Rinse mouth.

Dispose of contents and container in accordance with local, state, and federal regulations.



PIM016 (R2-0423)

ESSECO USA LLC - 4 Gatehall Drive - Parsippany, NJ 07054 - Tel 973-267-3330

ESSECO INDUSTRIAL

BICARBONATE D'AMMONIUM

FOOD GRADE FFQ

25kg

25 kg



BICARBONATE D'AMMONIUM

FOOD GRADE FFQ - AVEC 0.9% max MgCO₃ - CODE 1AJANE-0025KB

CONTIENT BICARBONATE D'AMMONIUM CAS 1066-33-7/ AVEC CARBONATE DE MAGNESIUM CAS 39409-82-0

AVERTISSEMENT

ENTREPOSER DANS LE RÉCIPIENT D'ORIGINE DANS UN ENDROIT FRAIS, SEC, BIEN VENTILÉ ET À L'ABRI DE L'HUMIDITÉ. POUR UNE URGENCE AUX ÉTATS-UNIS ET CANADA, APPELEZ CHEMTREC 800-424-9300

AVANT D'UTILISER, CONSULTER LA FICHE DE DONNÉES DE SÉCURITÉ

EXCLUSIVEMENT POUR USAGE PROFESSIONNEL

CONTENU FABRIQUÉ EN NORVÈGE

Attention

Nocif en cas d'ingestion.

Se laver les mains soigneusement après manipulation.

Ne pas manger, boire ou fumer en manipulant ce produit. EN CAS D'INGESTION: Appeler un médecin en cas de malaise. Rincer la bouche.

Éliminer le contenu et le récipient conformément à la réglementation locale, régionale et nationale.



PIM016 (R2-0423)

ESSECO USA LLC - 4 Gatehall Drive - Parsippany, NJ 07054 - Tel 973-267-3330

55.1 lbs

AMMONIUM BICARBONATE

FOOD GRADE FFQ

ESSECO INDUSTRIAL

55.1 lbs



AMMONIUM BICARBONATE

FOOD GRADE FFQ - WITH 0.9% max MgCO₃ - CODE 1AJANE-0025KB

CONTAINS AMMONIUM BICARBONATE CAS 1066-33-7/ WITH MAGNESIUM CARBONATE CAS 39409-82-0

ATTENTION

STORE IN THE ORIGINAL CONTAINER IN A COOL, DRY, WELL-VENTILATED LOCATION THAT IS PROTECTED FROM MOISTURE. IN CASE OF AN EMERGENCY INVOLVING THIS PRODUCT IN THE USA OR CANADA CONTACT CHEMTREC 800-424-9300

BEFORE USING, READ THE SAFETY DATA SHEET FOR THIS CHEMICAL

FOR PROFESSIONAL USE ONLY

CONTENTS MADE IN NORWAY

Warning

Harmful if swallowed. Wash hands thoroughly after handling.

Do not eat, drink or smoke when using this product. IF SWALLOWED: call a doctor if you feel unwell. Rinse mouth.

Dispose of contents and container in accordance with local, state, and federal regulations.



PIM016 (R2-0423)

ESSECO USA LLC - 4 Gatehall Drive - Parsippany, NJ 07054 - Tel 973-267-3330

ESSECO INDUSTRIAL

BICARBONATE D'AMMONIUM

FOOD GRADE FFQ

25kg